



Turning  
Polycarbonate  
into Architecture



---

# The Multi Advantages of Multi-Wall Polycarbonate

---





*Along with strong impact resistance and daylighting properties, the unique cell-like internal structure of multi-wall sheets produces high insulating values. A more in-depth understanding of the material's composition, performance characteristics and installation guidelines can help project teams better specify the product. Furthermore, partnering with an experienced manufacturer is key to selecting and installing the right product for the job.*

An excellent alternative to glass and fiberglass fenestration systems, polycarbonate (PC) is lightweight and offers comparable durability and light transmission properties, and superior impact resistance. It is easily moldable, highly versatile, easy to erect and supports a large range of design possibilities.

In particular, multi-wall (MW) sheets—the most commonly-specified PC material—is 85% lighter than glass, and like other PC types, delivers a high level of stiffness, thermal insulation, optical properties and UV blocking.

The product is ideal for skylights, roofing and glazing, facades, covered swimming pools and walkways, agricultural greenhouses, and signs and displays.

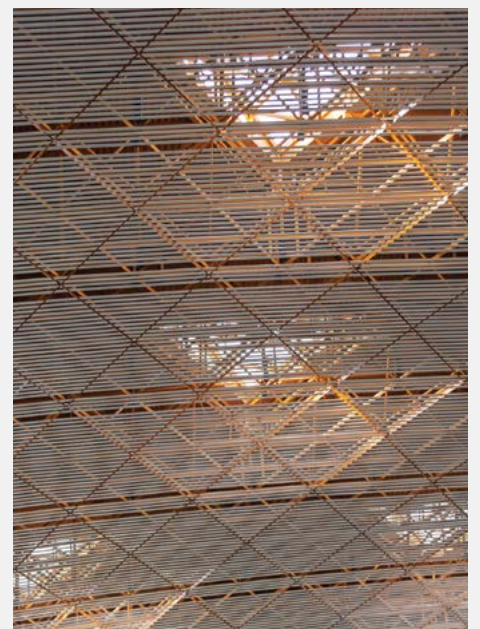
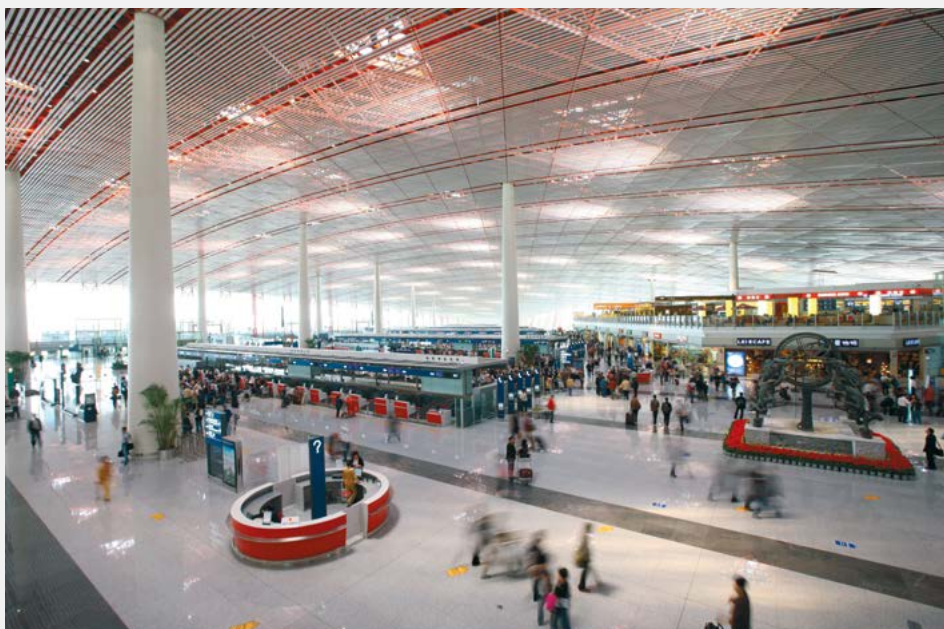

As an example of MW's versatility in design, triangular-shaped "dragon scale" skylights adorn the rooftop of Beijing International Airport's Terminal 3. In all, 45,000 square meters of Palram's 25 mm clear MW create a daylit interior and attractive exterior aesthetic.

At the same time, selecting the right thickness, structure and color parameters for a building project's specific design requirements—i.e., strength, insulation and light transmission levels—is essential.

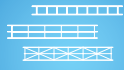

But in order to achieve this, designers and installers must be equipped with some basic knowledge of multiwall PC characteristics and installation guidelines.



## Internal Structure Differences

For starters, MW sheets are available in varying internal wall structures which each offer different performance characteristics.

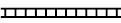
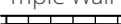
For example, a 6 mm-thick MW twin wall weighs just 1.3 Kg/m<sup>2</sup>, but only delivers a U-value of 3.5. A 20 mm-thick X-Lite structure weighs 2.8 Kg/m<sup>2</sup>, and offers a thermal insulating property of 1.85. And a 7-wall MW structure that is 25 mm thick, boosts insulation levels to 1.39, but weighs 3.4 Kg/m<sup>2</sup>.

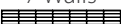
Structure	Thickness (mm)	Area Weight (Kg/m <sup>2</sup> )	U-Value (W/m <sup>2</sup> ·°K)
Twin Wall 	4	0.8	3.8
	4.5	1.0	3.7
	6	1.3	3.5
	8	1.5	3.3
	10	1.7	2.9
Triple Wall 	8	1.7	3.0
	10	2.0	2.7
	16	2.7	2.3
X-Lite 	16	2.5	2.1
	20	2.8	1.85
	25	3.0	1.7
	32	3.2	1.6
	35	3.5	1.5
	40	4.1	1.4
V-Structure 	20	2.8	1.85
	25	3.4	1.6
	32	3.6	1.5
	35	3.8	1.45
	40	4.0	1.35
7 Walls 	10**	1.9	2.3
	16	2.55	1.75
	20	2.9	1.55
	25	3.4	1.39

**Twin wall**  
6 mm



Weight 1.3 Kg/m<sup>2</sup>  
U-value 3.5

**X-Lite**  
20 mm



Weight 2.8 Kg/m<sup>2</sup>  
U-value 1.85

**7-wall**  
25 mm



Weight 3.4 Kg/m<sup>2</sup>  
U-value 1.39

With V-structure and triple wall structures also in the mix, it can be confusing to decide between the various size, weight and insulating options.

Generally speaking, better thermal insulation is achieved with more inner cells and thicker sheets, whereas better load capacity is accomplished when the walls' internal structure is formed as an X shape, as opposed to vertical walls.

For proper guidance in optimally selecting the best internal structure for a given project, it's important to solicit the expert input of reputable PC manufacturers such as Palram.



## Thermal insulation

As compared to flat solid and corrugated solid PC panels, MW is the best insulated PC solution, thanks to its unique geometrical structure with air spaces in between the inner walls. With the incorporation of special glazing systems, created with layered panels with fillers in between, insulation levels can be boosted even further.

These high insulation values drive down heating and air conditioning costs to the owner as the indoor air temperature is better maintained.



## Impact Resistance

A desirable option for hurricane and tornado regions, and for applications where vandalism and forced entry are concerns, PC enclosures deliver high levels of impact resistance.

Among the first window glazing materials to be certified by Florida's Miami-Dade County stringent building codes, the U.K.-based National Association of Rooflite Manufacturers describes PC as "boasting exceptional impact strength... with outstanding resistance to evenly-distributed loads in roofing applications."

Furthermore, the Army Corps of Engineers recognizes PC as part of the Unified Facilities DoD Minimum Criteria for Antiterrorism Standards for Buildings.

Although solid, monolithic sheets offer higher levels of impact resistance than MW, a thicker outer surface will leverage higher impact resistance values for MW.

Take Sydney ANZ Stadium, the former site of the 2000 Olympic Games, for example. 45,000 square meters of existing roof was renovated with MW panels, made with an extra thick outer layer, to withstand the frequent hail storms experienced in this climate.



## Aesthetics

In addition to the numerous performance attributes offered by MW panels, this unique material lends a number of aesthetic advantages.

For starters, MW's translucency supports back lighting to create attractive visual effects at night. The light source is hidden behind the MW and its translucent nature enables an evenly distributed dispersion of light.

Available in all colors of the rainbow, Palram also offers a number of "solar smart" colors, which selectively allow visible light to pass while deflecting unwanted Infra-red heat. This is particularly important when specifying the product for hotter climates.

Palram also offers the option of producing the sheets in two different colors, one on each side. MW with a matte finish is also available for enhanced glare reduction. In addition, a diffuser additive creates a greater diffusion of light.

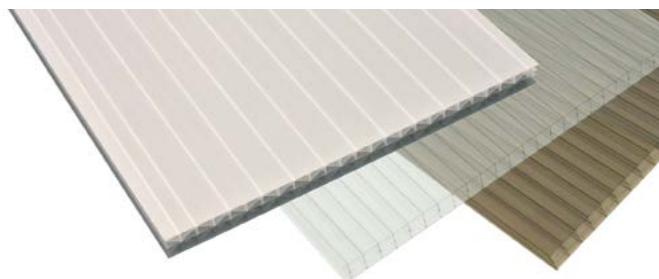

Case in point, at the Aquanation pool in Ringwood, Australia. Both the diffuser and matte additives were specified for the skylights and curtainwall system to deliver soft, comfortable diffused light inside the pool. Furthermore, no glare is viewed from the surrounding buildings.



It should be noted that MW does not offer transparency, only translucency. This produces the diffused light where objects behind the panels will appear blurry. This is often an advantage in public spaces where the softer, diffused light is more comfortable. Another benefit is the fact that any defects, stains, bird droppings, etc., are less visible.

For example, in creating semi-translucent study pods at Griffith University in Gold Coast, Australia, multiwall PC architectural panels were installed in this manner, resulting in a highly effective and efficient space.

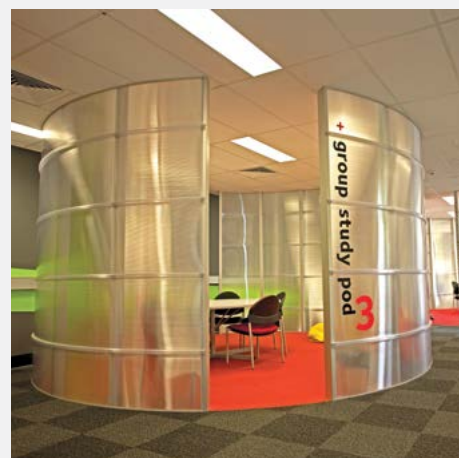

## Proper Installation

Once the right product is chosen for the job, it's time to install it. A note of caution, though. MW sheets offer a whole host of advantages to building owners and occupants. However, the full extent of these benefits will only be realized if the product is properly installed.

For starters, the sheets should be installed with the rib channels sloping downwards in order to reduce the accumulation of dirt and best leverage the gravity-driven drainage of condensation moisture. The sheets should also be installed with the adjoining edges connected by a glazing profile best suited to the glazing system.

For roofs, overhead skylights and sheets installed in a horizontal position, the slope must be at least 5 percent, more preferably 10 percent, as steeper slopes offer better rainwater drainage and self-cleaning, and reduce the risk of water and dirt infiltration through the connectors and fastening screws, if used. Furthermore, a steeper slope diminishes the visual effect of sheet deflection caused by loading.

Vertical installation avoids accumulation of moisture in the inner channels. If the product is installed indoors, then moisture and dust is not a problem.

Installers should also be aware that the weaker dimension is the width of the sheet—the one perpendicular to the extrusion—and suffers more from deflection under loads, so the sheets should be installed lengthwise. Incidentally, this is why the X structures are stronger.

For curved installations, the sheets should be curved in the direction of the extrusion, or lengthwise. Bending the sheet also makes it more resistant to loads. At the same time, designs and installations need to stay within the permitted arching radius. A good rule of thumb is calculating the minimum radius as the thickness of the sheet times 175. This recommendation applies to cold bending by human force at the installation site. With hot bending, where sheets are heated in the workshop and then bent using special equipment, smaller radii can be achieved.

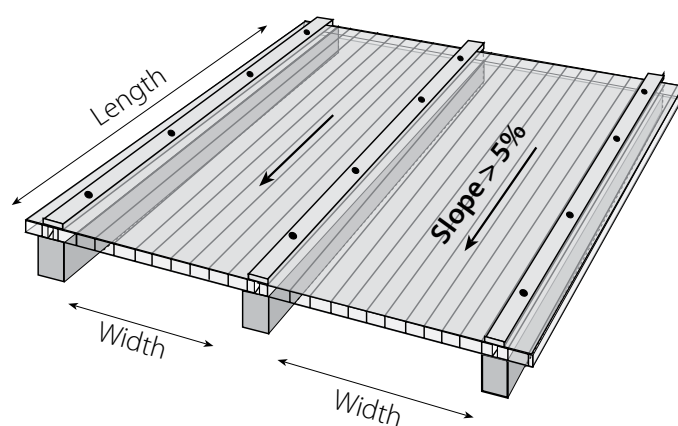

Based upon how the sheets will be installed, the contractor will need to make certain spacing and load calculations. Fortunately, Palram can help with that.

After cutting the sheets, they should then be placed inside a four-sided frame or supporting structure and clamped on all sides. For two-sided clamped glazing, no mid-sheet fastening is required. Instead, long glazing sheets are held in place by two glazing profiles on both longitudinal edges.

For two-sided clamping with arched glazing, the internal stresses induced by the glazing will actually give the sheets extra strength and rigidity in both directions. Rigidity and support spans will increase as the curve radius is reduced.

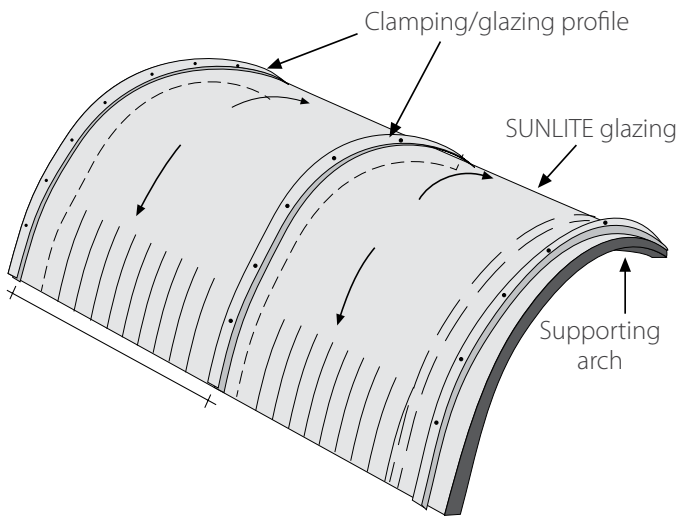
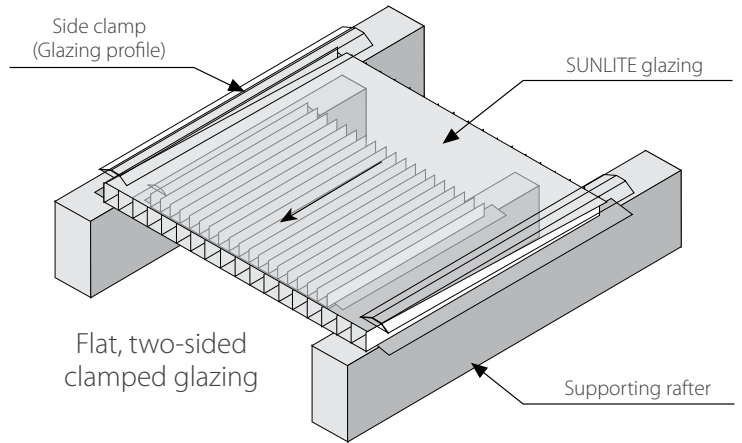

While Do-It-Yourself installations are typically done by drilling a hole through the sheet, for better quality and longer lasting performance, glazing bars from either PC or aluminum should be used instead and one should avoid screwing through the sheets.

When working with MW sheets, it's important to keep the sheets clean. Washing with water is usually sufficient. For oil or tar stains, a watered-down isopropyl alcohol solution should be adequate. Generally speaking, the sheets should be wiped down with liquid or water, but not wiped when dry, to avoid scratching the surface. Installers should also avoid repeatedly sliding the sheets over each other as this generates static electricity and attracts dirt and dust.

 **In Conclusion**

Impact resistant, translucent, versatile and lightweight, MW systems—available from Palram as both a single sheet or as a full standing seam system—are a great alternative to glass, delivering a soft, beautiful daylit or nightlit aesthetic.

Overall, when specifying MW sheets, the most important factors to evaluate are the insulating U-value, impact resistance, wind/snow load capabilities and weight per area unit. Ultimately, it's the weight that will most directly impact the price.

To view a varied selection of project profiles, technical documents or to request a sample, visit Palram at [www.palram.com](http://www.palram.com).

[www.palramprojects.com](http://www.palramprojects.com) 



**PALRAM H.Q.**  
Tel: +972 4 8459900  
Fax: +972 4 8444012  
[palram@palram.com](mailto:palram@palram.com)

**PALRAM EUROPE LTD.**  
Tel: +44 1302 380777  
Fax: +44 1302 380788  
[sales.europe@palram.com](mailto:sales.europe@palram.com)

**PALRAM AMERICAS**  
Tel: 610 2859918  
Fax: 610 2859928  
[palramamericas@palram.com](mailto:palramamericas@palram.com)

